

2009 Quick Reference Guide

CAMRY

Have a question about the main features of your new Toyota? Find the answers quickly and easily in this Quick Reference Guide, which includes highlights from the *Owner's Manual*. For more detailed information, and helpful interactive demonstrations and tips, visit www.Toyotaiguide.com. This user-friendly website makes learning all about your new vehicle fun and easy.

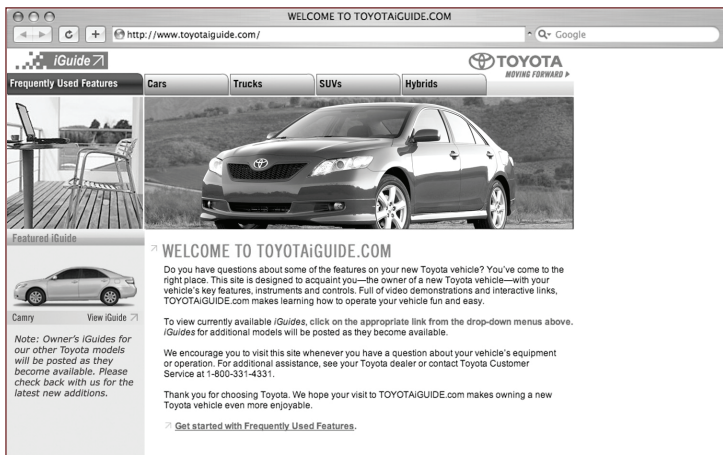

www.Toyotaiguide.com

This *iGuide* is not intended as a substitute for the *Owner's Manual* located in the vehicle's glove box. We strongly encourage you to review the *Owner's Manual* and supplementary manuals so you will have a better understanding of the vehicle's capabilities and limitations. Important **Cautions**, to help you avoid injuries, and **Notices**, to help you avoid equipment damage or malfunction, can also be found in the *Owner's Manual*.

2009 Camry Quick Reference Guide

OVERVIEW

Engine maintenance	9
Fuel tank door release and cap	8
Hood release	9
Indicator symbols	5
Instrument cluster	4
Instrument panel	2-3
Keyless entry^{1,2}	6
Light control-Instrument panel	8
Smart Key system^{1,2}	7

FEATURES/OPERATIONS

Air Conditioning/Heating	18-19
Audio	20-21
Auto lock functions²	10
Automatic Transmission	10
Clock	18
Cruise control	16
Cup holders	22
Garage door opener (HomeLink [®]) ³	16
Lights¹ & turn signals	14
Moonroof	12
Multi-information display	15
Parking brake	11
Power outlets-12V DC	15
Seat adjustments-Front	13
Seat adjustments-Rear	13
Seat heaters	19
Seats-Head restraints	12
Steering lock release	11
Steering wheel switches	21
Sunshade-Rear	17
Telephone controls (Bluetooth [®])	17
Tilt and telescopic steering wheel	11
Windows-Power	12
Windshield wipers & washers	14

SAFETY AND EMERGENCY FEATURES

Child comfort guide	24
Door locks	23
Doors-Child safety locks	23
Seat belts	23
Seat belts-Shoulder belt anchor	24
Spare tire & tools	25
Tire Pressure Warning System	24
Trunk-Internal release	25

¹ Visit your Toyota dealer for information on customizing this feature.

² Programmable by customer. Refer to the Owner's Manual for instructions and more information.

³ HomeLink[®] is a registered trademark of Johnson Controls, Inc.

OVERVIEW

Instrument panel

Steering wheel controls

XLE and LE models

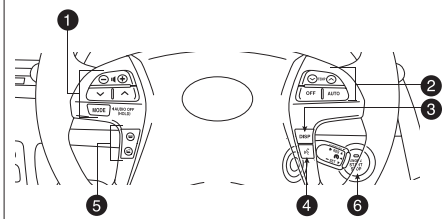

Steering wheel controls

SE model

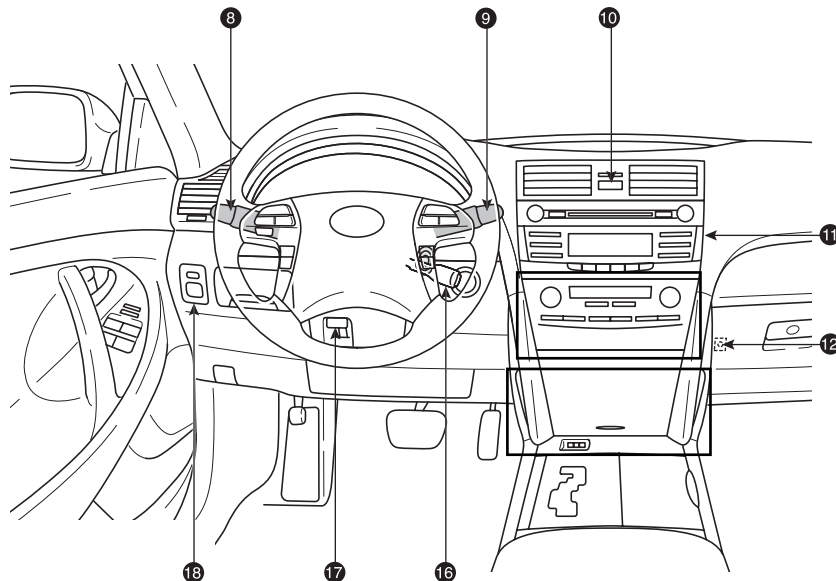
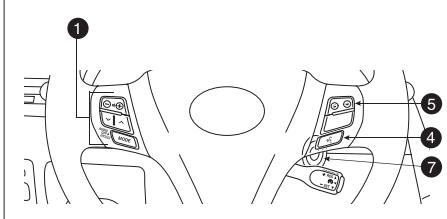

Automatic Air Conditioning

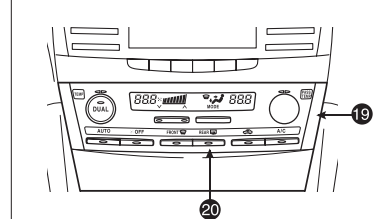

Manual Air Conditioning

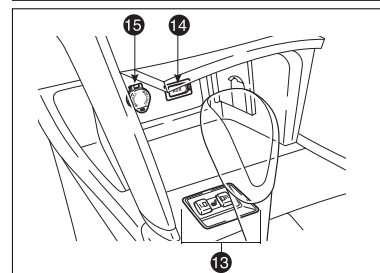
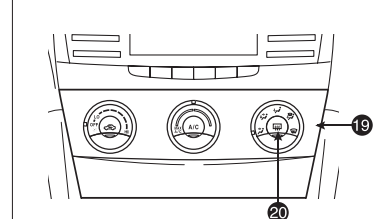

- ❶ Steering wheel audio controls²
- ❷ Steering wheel climate controls¹
- ❸ Multi-information display button¹
- ❹ Voice command button^{1,2}
- ❺ Telephone controls^{1,2}
- ❻ “ENGINE START STOP” button (Smart Key)¹
- ❼ Engine switch (standard key)¹
- ❽ Headlight and turn signal controls/Headlight, turn signal and front fog light¹ controls
- ❾ Wiper and washer controls
- ❿ Emergency flasher button

- ⓫ Audio system²
- ⓬ Tire Pressure Warning System reset
- ⓭ Seat heater controls¹
- ⓮ AUX audio jack
- ⓯ 12V DC Power outlet
- ⓰ Cruise control
- ⓱ Tilt and telescopic steering lock release
- ⓲ Power outside rearview mirror controls
- ⓳ Air Conditioning controls
- ⓴ Outside rearview mirror¹/Rear window defogger button

¹ If equipped

² For details, refer to the “Navigation System Owner’s Manual.”

Instrument cluster

With multi-information display

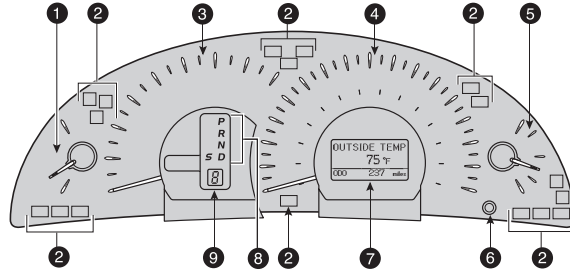

Without multi-information display

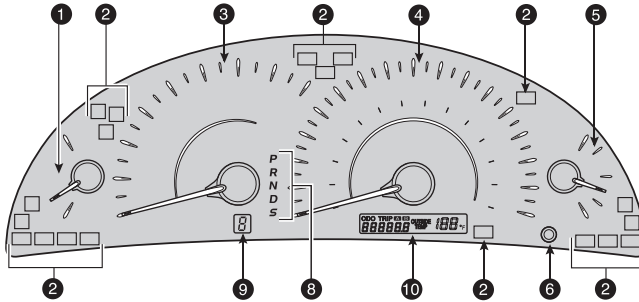

- ❶ Engine coolant temperature
- ❷ Service indicator and reminder
- ❸ Tachometer
- ❹ Speedometer
- ❺ Fuel gauge
- ❻ Trip meter reset/Instrument panel light control
- ❼ Multi-information display
- ❽ Automatic Transmission shift position indicator
- ❾ Sequential shift display*
- ❿ Odometer, two trip meters and outside temperature display

* If equipped

Indicator symbols

For details, refer to “Indicators and warning lights,” Section 2-2, 2009 Owner’s Manual.

- BRAKE** Brake system warning¹
- Driver seat belt reminder (alarm will sound if speed is over 12 mph)
- Front passenger seat belt reminder (alarm will sound if speed is over 12 mph)
- Charging system warning¹
- Front passenger occupant classification or front passenger air bag ON/OFF indicator¹
- Low engine oil pressure warning¹
- Malfunction/Check Engine indicator¹
- MAINT REQD** Engine oil replacement reminder¹
- Low fuel level warning
- Open door warning
- Airbag SRS warning¹
- Master warning
- Low Tire Pressure Warning¹
- Low windshield washer fluid level warning¹
- Theft deterrent/Engine immobilizer system indicator
- Headlight low/high beam indicator
- Turn signal indicator
- Front fog light indicator
- Slip indicator¹
- VSC** Vehicle Stability Control¹
- Cruise control indicator²
- ABS** Anti-lock Brake System warning¹

¹ If indicator does not turn off within a few seconds of starting engine, there may be a malfunction. Have vehicle inspected by your Toyota dealer.

² If this light flashes, refer to “Cruise control,” Section 2-4, 2009 Owner’s Manual.

Keyless entry

Locking operation

Without Smart Key system

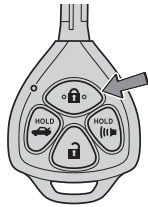

With Smart Key system



Push

Unlocking operation

Without Smart Key system

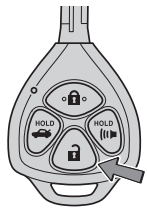

With Smart Key system



Push ONCE: Driver door
TWICE: All doors

NOTE: If a door is not opened within 60 seconds of unlocking, all doors will relock for safety.

Trunk lid

Without Smart Key system

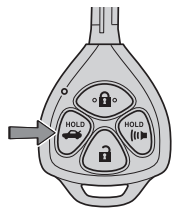

With Smart Key system



Push and hold

Panic button



Push and hold

Smart Key system* (if equipped)

Start function

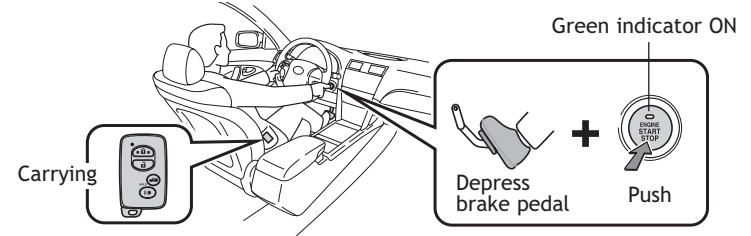

NOTE: Gear shift lever must be in Park and brake pedal depressed.

Power (without starting engine)

Without depressing the brake pedal, pressing the “ENGINE START STOP” switch will change the operation mode in succession from:

ACC Accessories such as the radio will operate.

ON Power ON; the engine not running.

OFF All systems OFF.

Locking/Unlocking operation

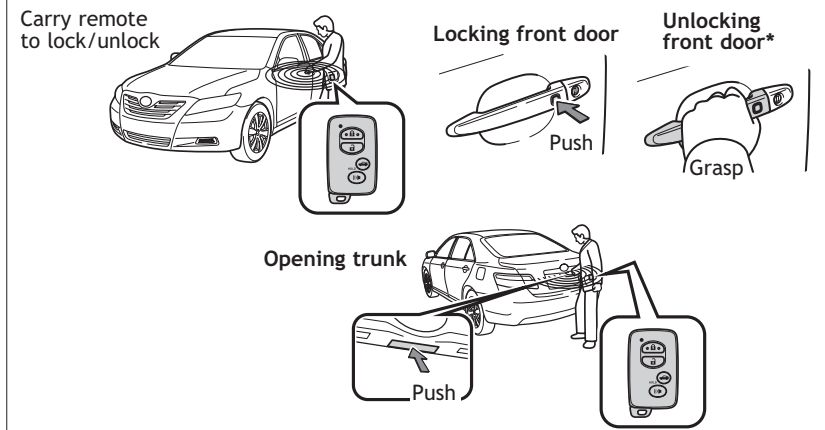

* Driver door unlocking function can be programmed to unlock driver door only, or all doors. Grasping front passenger door handle will unlock all doors.

NOTE: Doors may also be locked/unlocked using remote.

Fuel tank door release and cap

NOTE: Tighten until one click is heard. If the cap is not tightened enough, Check Engine “” indicator may illuminate.

Light control-Instrument panel

Brightness control

Hood release

Pull up latch and raise hood

Engine maintenance

4 cylinder (2AZ-FE) engine	6 cylinder (2GR-FE) engine

- ① Engine oil filler cap
- ② Engine oil level dipstick
- ③ Windshield washer fluid tank
- ④ Engine coolant reservoir

Note: Regularly scheduled maintenance, including oil changes, will help extend the life of your vehicle and maintain performance. Please refer to the “Owner’s Warranty Information Booklet,” “Scheduled Maintenance Guide” or “Owner’s Manual Supplement.”

FEATURES/OPERATIONS

Auto lock functions

Automatic door locks can be programmed to operate in four different modes, or turned OFF.

- Doors lock when shifting from Park.*
- Doors lock when the vehicle speed goes above approximately 12 mph.
- Doors unlock when shifting into Park.*

Vehicles without Smart Key system

-Doors unlock when the engine switch is set from “ON” to “ACC” or “LOCK” and driver’s door is opened.

Vehicles with Smart Key system

-Doors unlock when the “ENGINE START STOP” switch is set to ACCESSORY mode or OFF and driver’s door is opened.

* Automatic Transmission only

Refer to the *Owner’s Manual* for more details.

Automatic Transmission (if equipped)

4 cylinder (2AZ-FE) engine

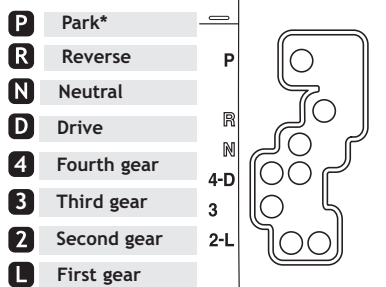

6 cylinder (2GR-FE) engine

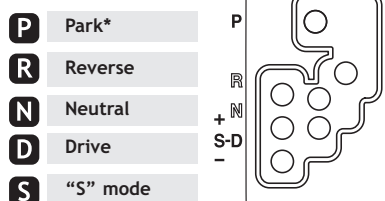

* The “ENGINE START STOP”/engine switch must be ON and the brake pedal depressed to shift from “Park.”

“S” (Sequential) mode

Shift the shift lever to “S” position from “D” position.

Floor shift type:

- +: Upshift (push and release)
- : Downshift (pull and release)

Downshifting increases power going uphill, or provides engine braking downhill. For best fuel economy during normal driving conditions, always drive with the shift lever in the “D” position.

Steering lock release

Smart Key system*

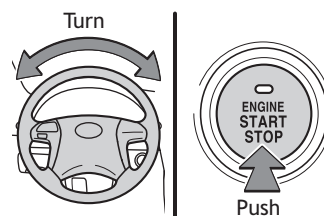

Without Smart Key system

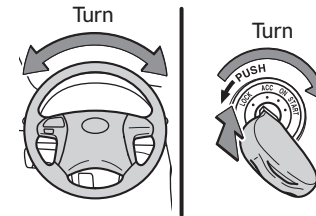

* Gently turn wheel while pressing the ENGINE START STOP switch. If the lock does not release, the switch will flash green.

Tilt and telescopic steering wheel

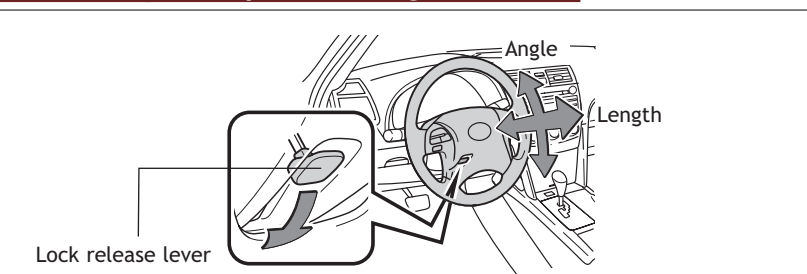

Hold wheel, push lever down, set angle and length, and return lever.

Note: Do not attempt to adjust while the vehicle is in motion.

Parking brake

Lever type

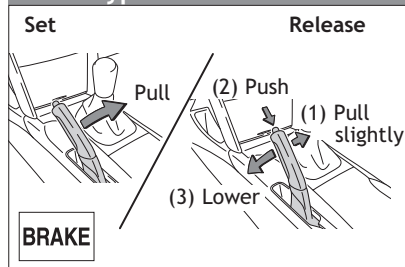

Pedal type

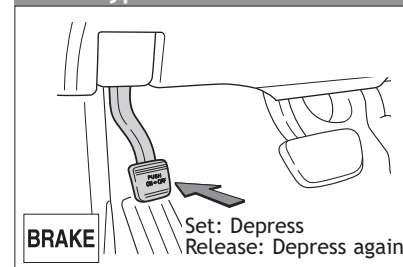

Windows-Power

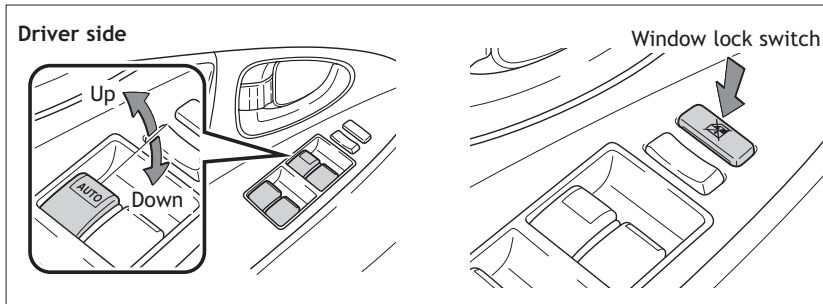

Automatic operation (driver side only) Push the switch completely down or pull it completely up and release to fully open or close.* To stop window midway, lightly push the switch in the opposite direction.

Window lock switch Deactivates all passenger windows. Driver's window remains operable.

* If equipped

Moonroof (if equipped)

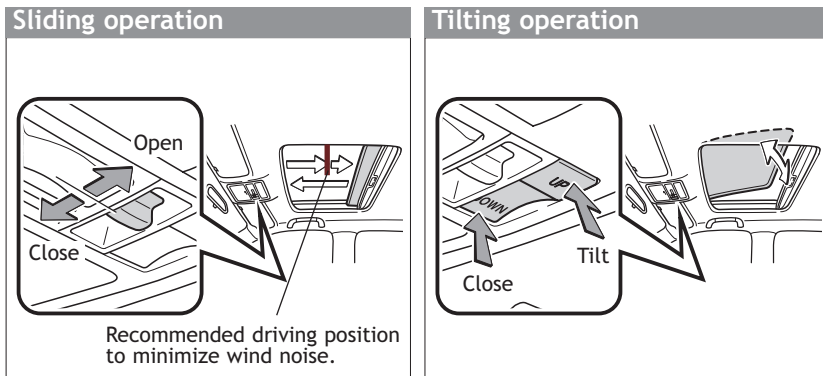

Push once to open; moonroof will automatically stop at the recommended position. Push again to open completely.

Seats-Head restraints

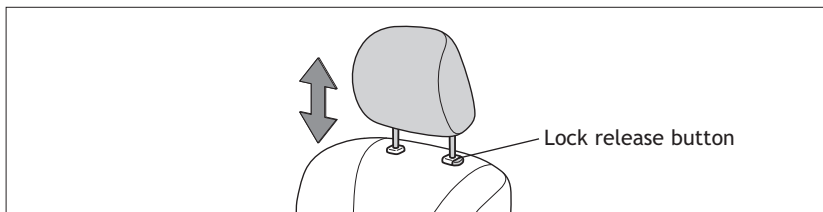

Seat adjustments-Front

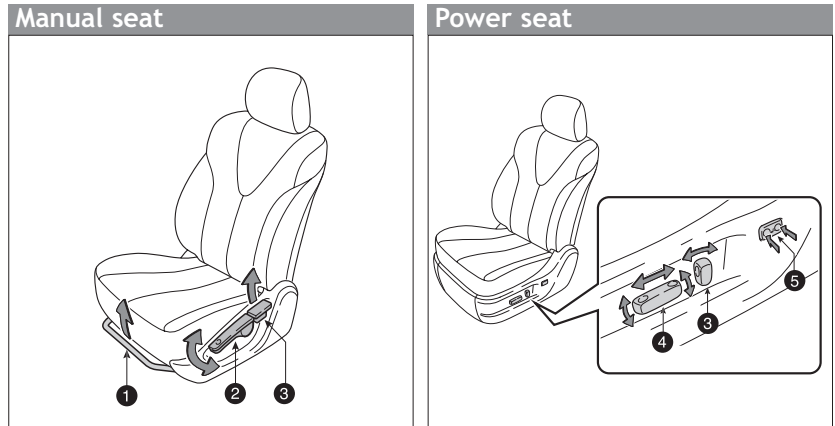

- ① Position
- ② Height crank (driver side only)
- ③ Seatback angle
- ④ Position, cushion angle (driver side only) and height (driver side only)
- ⑤ Lumbar support (driver side only)

Seat adjustments-Rear (if equipped)

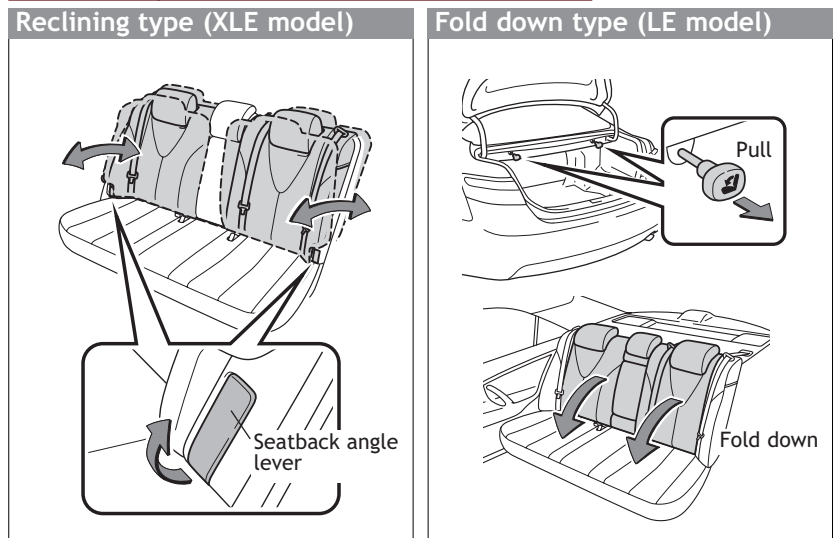

Refer to the *Owner's Manual* for more details.

Windshield wipers & washers

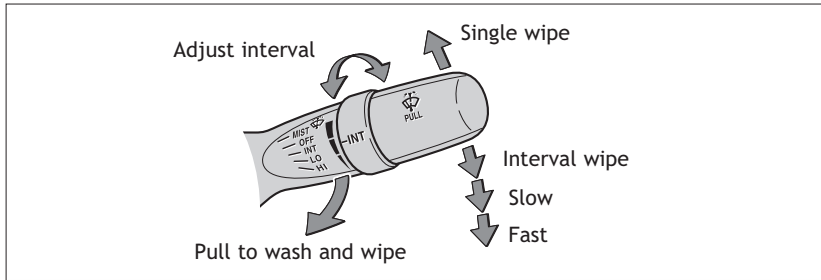

Lights & turn signals

Headlights

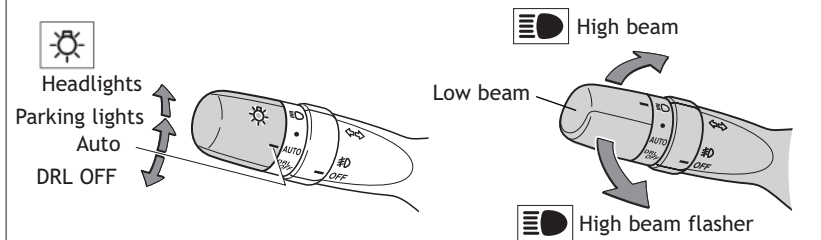

- Daytime Running Light system (DRL) Automatically turns on the turn signal lights at a reduced intensity.
- Automatic light cut off system Automatically turns lights off after a delay of 30 seconds, or the lock switch on remote may be pushed.

Front fog lights (if equipped)

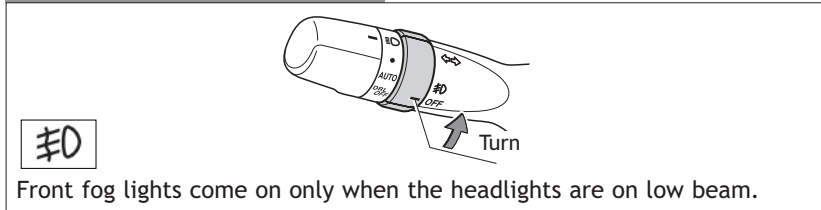

Turn signals

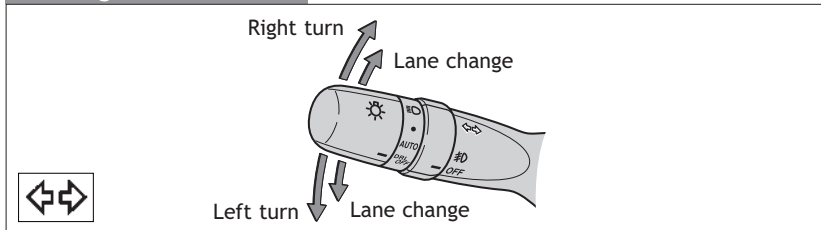

Power outlets-12V DC

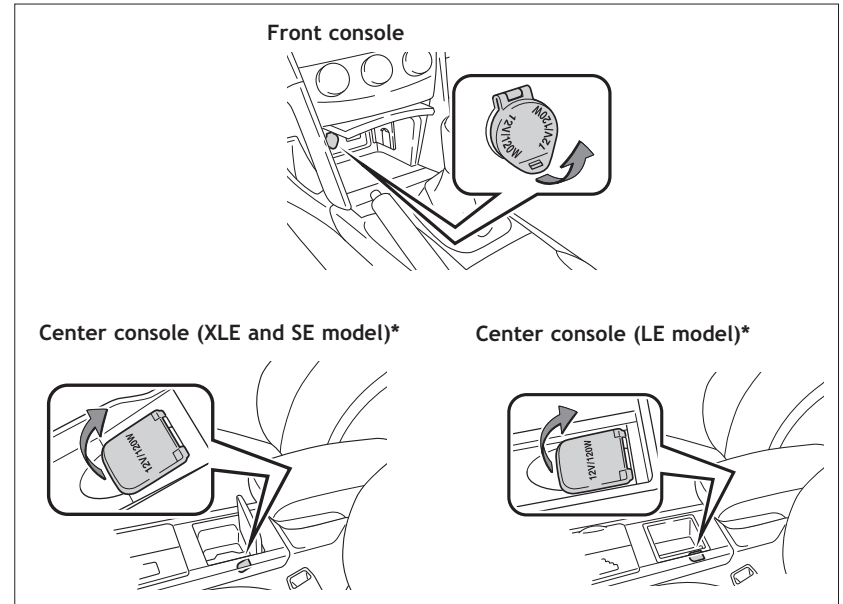

The “ENGINE START STOP” switch/engine switch must be in the “ACC” or “ON” position to be used.

* If equipped

Multi-information display (if equipped)

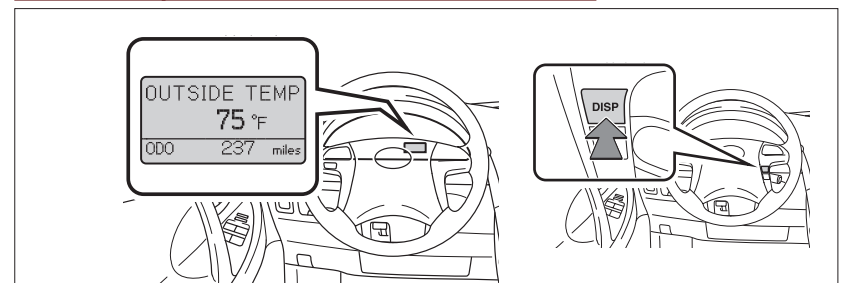

Push “DISP” to change information in the following:

- (1) Outside temperature
- (2) Miles left on remaining fuel
- (3) Current gas mileage
- (4) Running distance from engine start
- (5) Average vehicle speed from engine start
- (6) Multi-information display OFF
- (7) Zoom display of odometer and trip meter

Garage door opener (HomeLink®)* (if equipped)

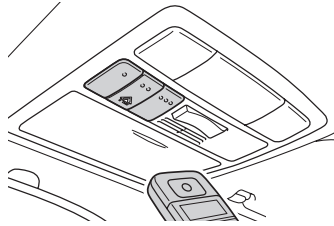

Garage door openers manufactured under license from HomeLink®* can be programmed to operate garage doors, estate gates, security lighting, etc.

Refer to “Garage door opener,” Section 3-6 in the *Owner’s Manual* for more details.

For programming assistance, contact the Toyota Customer Experience Center at 1-800-331-4331, or visit <http://www.homelink.com>.

* HomeLink® is a registered trademark of Johnson Controls, Inc.

Cruise control

Turning system ON/OFF

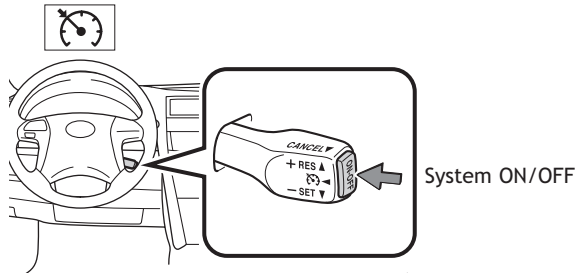

Functions

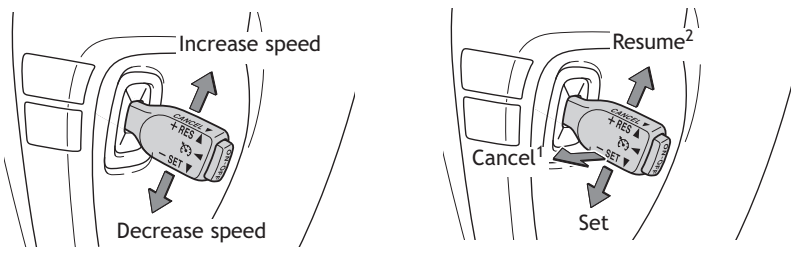

¹ The set speed may also be cancelled by depressing the brake pedal or clutch pedal (Manual Transmission only).

² The set speed may be resumed once vehicle speed exceeds 25 mph.

Telephone controls (Bluetooth®) (if equipped)

Audio unit

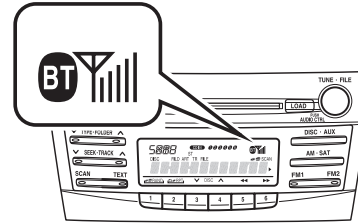

Microphone

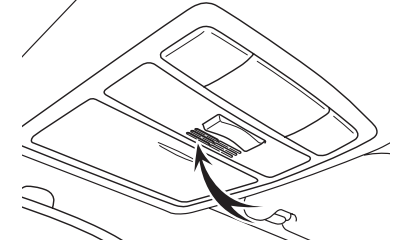

Steering wheel telephone switches

XLE and LE models

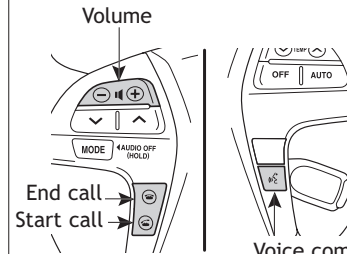

SE model

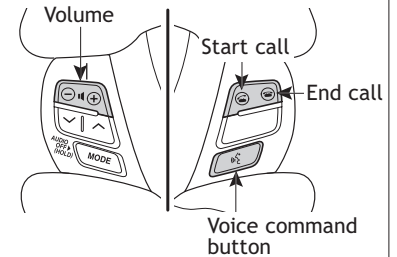

Bluetooth® technology allows you to place or receive calls without taking your hands from the steering wheel or using a cable to connect the compatible telephone and the system.

Refer to “Hands-free phone system (for cellular phone),” Section 3-3 in the *Owner’s Manual* for more details.

Sunshade-Rear (if equipped)

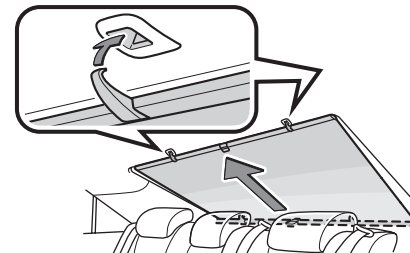

Clock

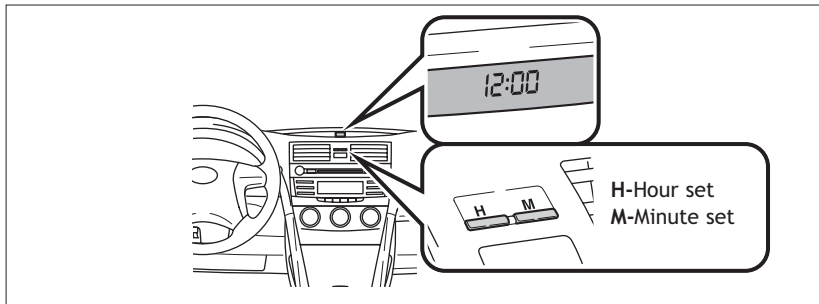

Air Conditioning/Heating

Manual Air Conditioning

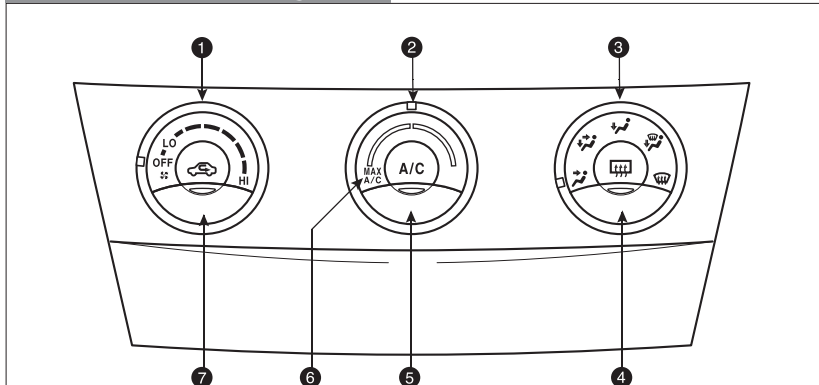

- 1 Fan speed
- 2 Temperature
- 3 Airflow vent
In “” or “” mode, use fresh air (“” indicator OFF) to reduce window fogging.
- 4 Outside rearview mirror*/Rear defogger
- 5 Air Conditioning ON/OFF
Use fresh air to quickly cool interior, then change to recirculate for cooler air.
- 6 Use for quick cooling. MAX A/C changes air intake to recirculate. It is not possible to change intake to fresh.
- 7 Fresh or recirculated cabin air

* If equipped

Automatic Air Conditioning

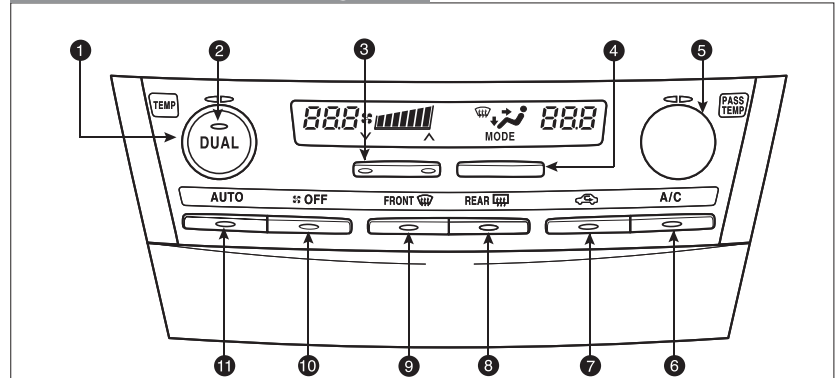

- 1 Temperature (driver side)
- 2 “DUAL” button
Indicator ON: Separate temperature settings for driver and passengers.
Indicator OFF: Synchronize temperature settings for driver and passengers.
- 3 Fan speed
- 4 Airflow vent
In “” or “” mode, use fresh air (“” indicator OFF) to reduce window fogging.
- 5 Temperature (passenger side)
- 6 Air Conditioning ON/OFF
- 7 Fresh or recirculated cabin air
- 8 Outside rearview mirror/Rear defogger
- 9 Windshield airflow/defogger
- 10 Climate control OFF
- 11 Automatic climate control ON
Adjusting the temperature setting will cause the airflow vents, air intake and fan to adjust automatically.

Seat heaters (if equipped)

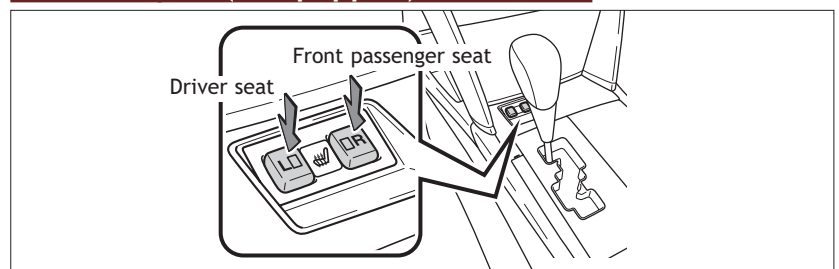

Audio

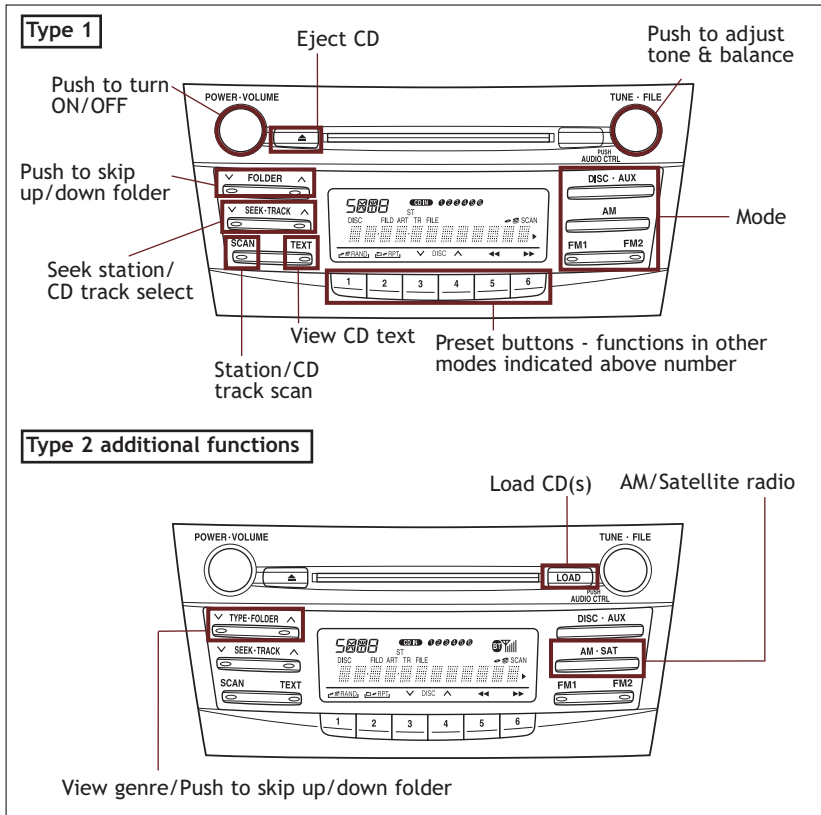

CD PLAYER

To scan tracks on a disc Push and hold "SCAN." Push again to hold selection.

CD changer (Type 2 only)

- To load one disc Push "LOAD" and insert one disc.
- To load multiple discs Push and hold "LOAD" until you hear a beep. Insert one disc. Shutter will close and then re-open for next disc.

To select a file (MP3/WMA only) Turn "TUNE-FILE."

To select a folder (MP3/WMA only) Push either side of "FOLDER."

RADIO

To preset stations Tune in the desired station and hold down a preset button (1-6) until you hear a beep. Push desired preset button (1-6) to select.

To scan stations Push and hold "SCAN" to scan preset stations. Push again to hold selection.

AUX audio jack

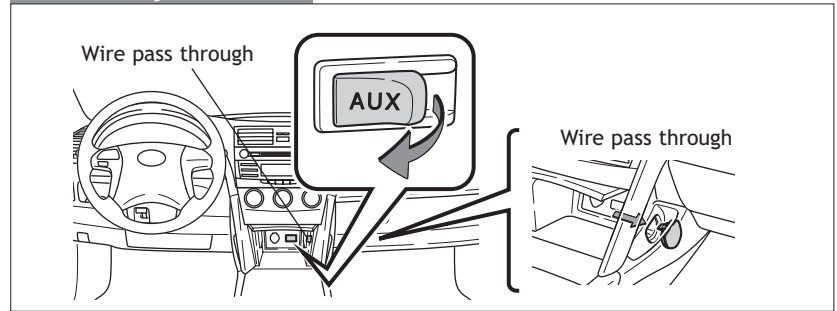

By inserting a mini plug into the AUX audio jack, you can listen to music from a portable audio device through the vehicle's speaker system.

Steering wheel switches (if equipped)

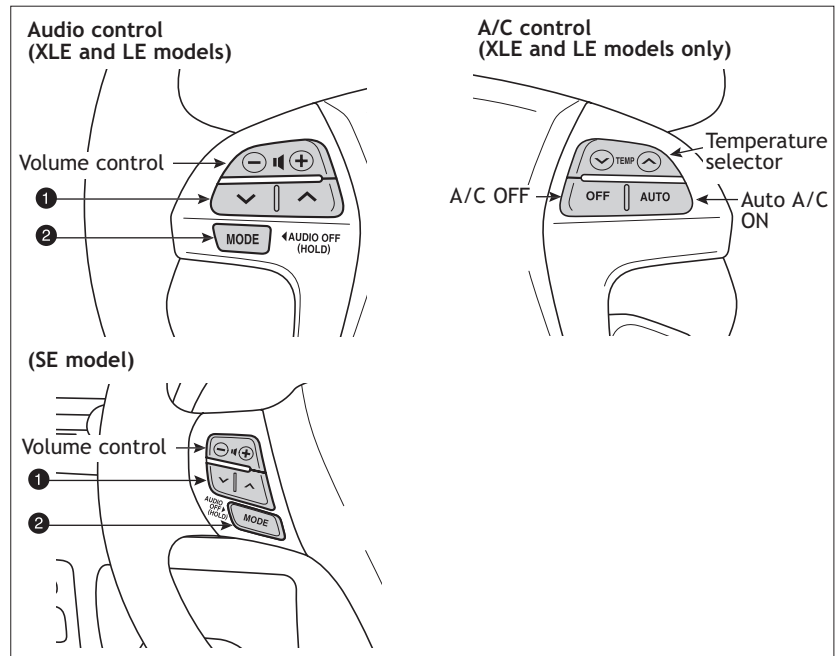

1 "V A"

-In radio mode Push to select a preset station; push and hold to seek the next strong station.

-In CD mode Push to skip up or down to next/previous track.

2 "MODE"

Push to turn audio ON and select an audio mode. Push and hold to turn the audio system OFF.

Cup holders

Front

Manual Transmission models

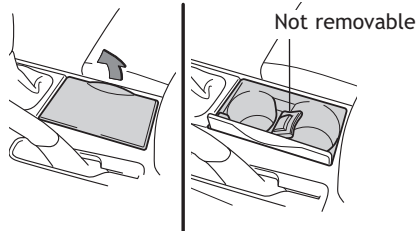

Automatic Transmission models

XLE and SE models

LE model

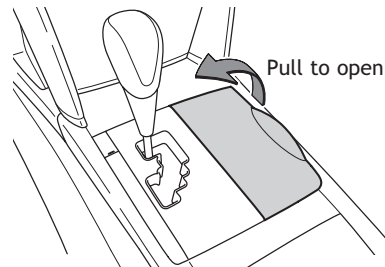
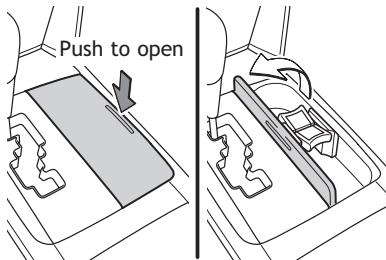

Rear

XLE and SE models

LE model

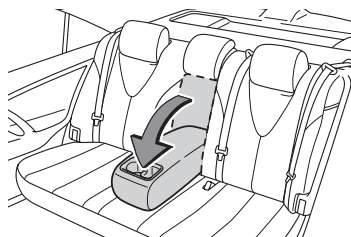
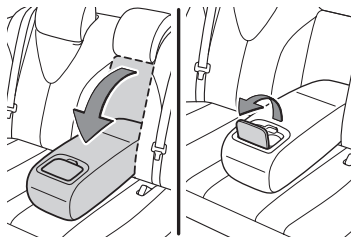

Door locks

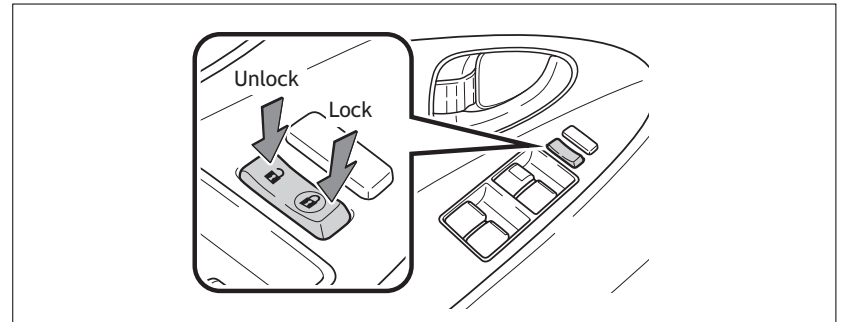

Doors-Child safety locks

Rear door

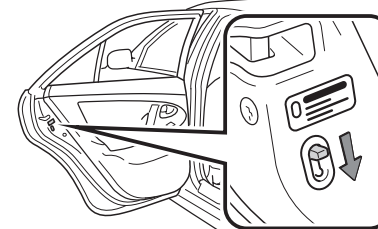

Moving the lever to "LOCK" will allow the door to be opened only from the outside.

Seat belts

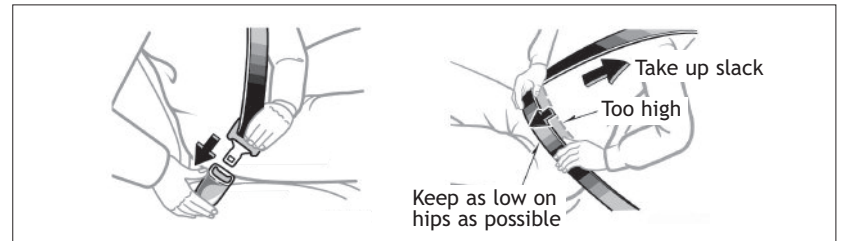

If belt is fully extended, then retracted even slightly, it cannot be re-extended beyond that point, unless fully retracted again. This feature is used to help hold child restraint systems securely.

To find more information about seat belts, and how to install a child restraint system, refer to the *Owner's Manual*.

Seat belts-Shoulder belt anchor

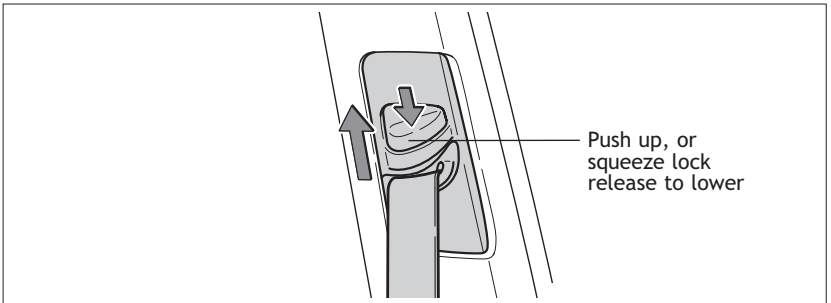

Child comfort guide

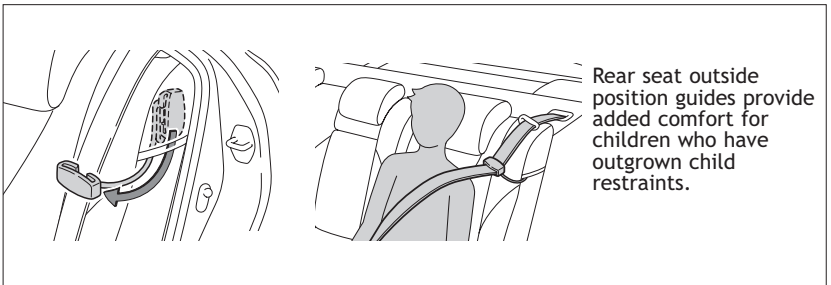

Tire Pressure Warning System

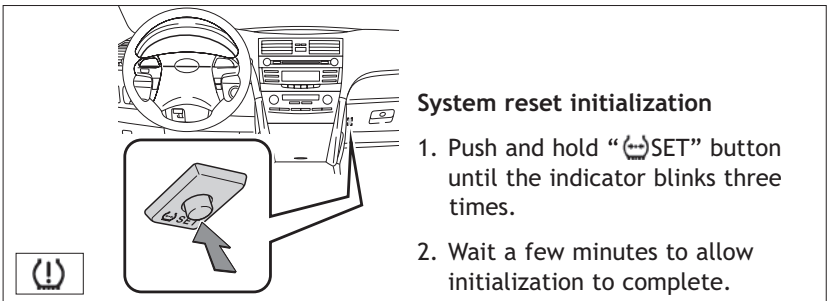

If tire pressure becomes critically low on any of the tires (excluding spare), indicator comes on. Pushing “(SET)” button should not turn off the light. Correctly adjusting tire inflation will turn off the light after a few minutes. After replacing/rotating tire or wheels, the system must be initialized.

Refer to the *Owner's Manual* for more details.

Spare tire & tools

Tool location

With compact spare tire

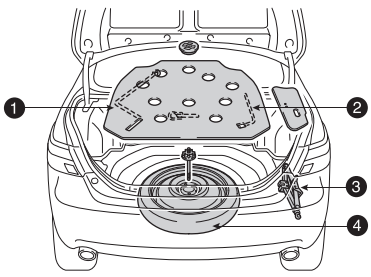

- 1 Jack handle
- 2 Wheel nut wrench
- 3 Jack
- 4 Spare tire

Without compact spare tire

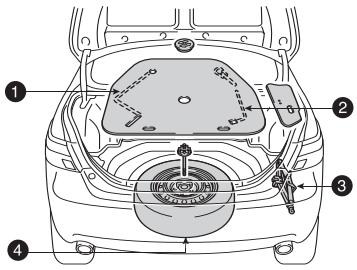

Removing the spare tire

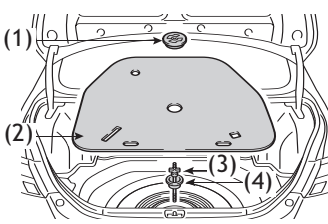

- (1) Loosen and remove the nut.
- (2) Remove the spare tire cover.
- (3) Loosen and remove the bolt.
- (4) Remove the spacer (with aluminum wheels).

Refer to the *Owner's Manual* for tire changing and jack positioning procedures.

Trunk-Internal release

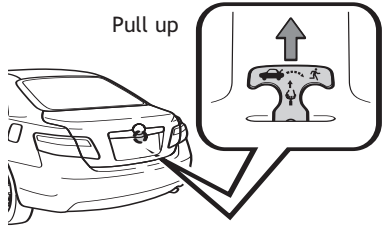



Customer Experience Center
1-800-331-4331